



**Sonnenschutz-Vorhangelemente  
Elementi tenda e parasole**

**decordesign**

Ein komplettes  
Edelstahlprogramm  
für Ihr modernes Zuhause

Un programma completo  
in acciaio inox per  
la vostra casa moderna



**decordesign**

## Sonnenschutz- Vorhangelemente

Unendliche Kombinations-  
möglichkeiten lassen Ihrer  
Fantasie freien Lauf

## Elementi tenda e parasole

Diverse possibilità di  
combinazione lasciano ampio  
spazio alla vostra fantasia

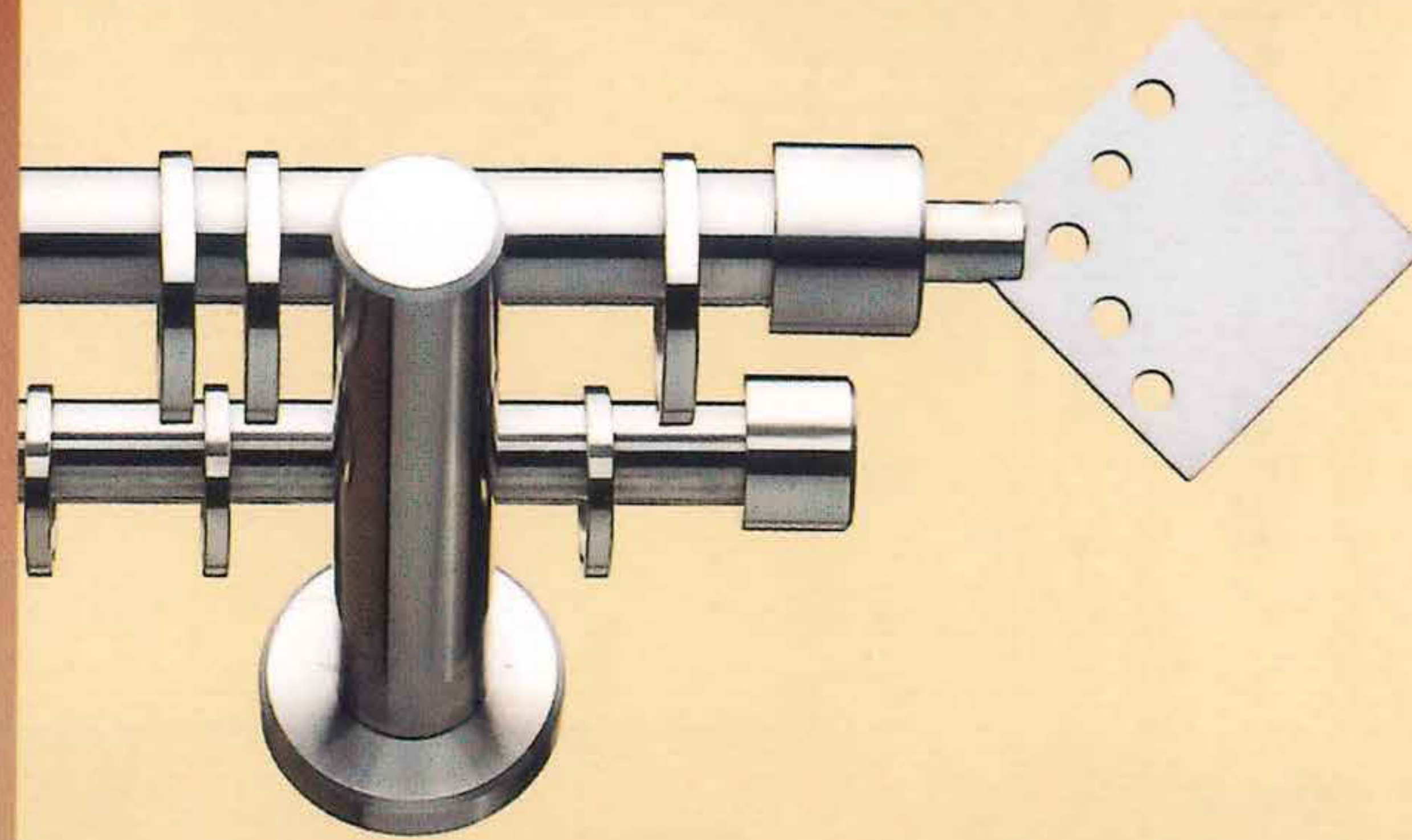

Mod. Prag - Berlin Ø 16 mm, Art. 16.31-01  
Abb. Mod. Prag - Berlin Ø 20 mm, Art. 20.31-01  
Mod. Prag - Berlin Ø 25 mm, Art. 25.31-01

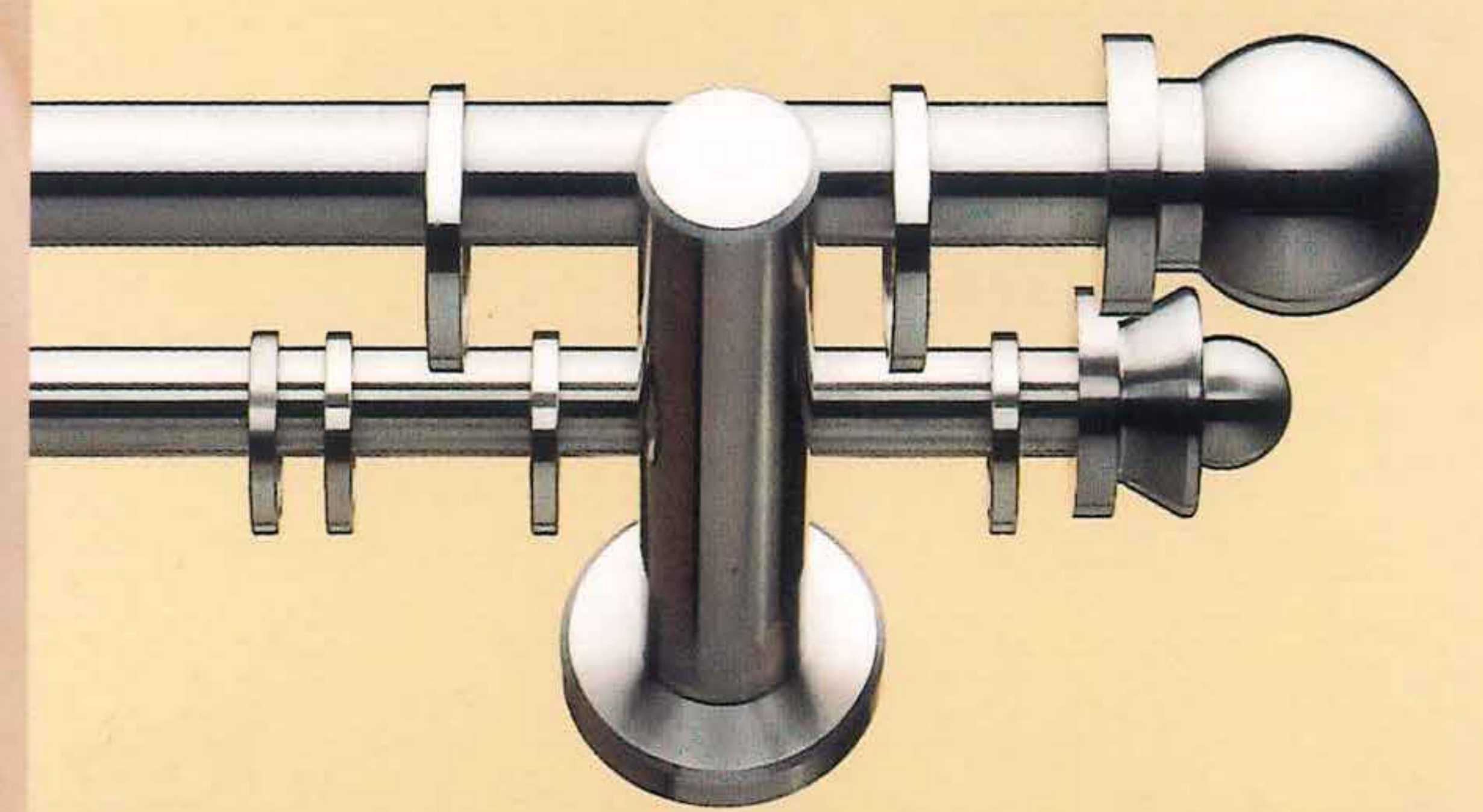

Mod. Madrid - Istanbul Ø 16 mm, Art. 16.22-23  
Abb. Mod. Madrid - Istanbul Ø 20 mm, Art. 20.22-23  
Mod. Madrid - Istanbul Ø 25 mm, Art. 25.22-23

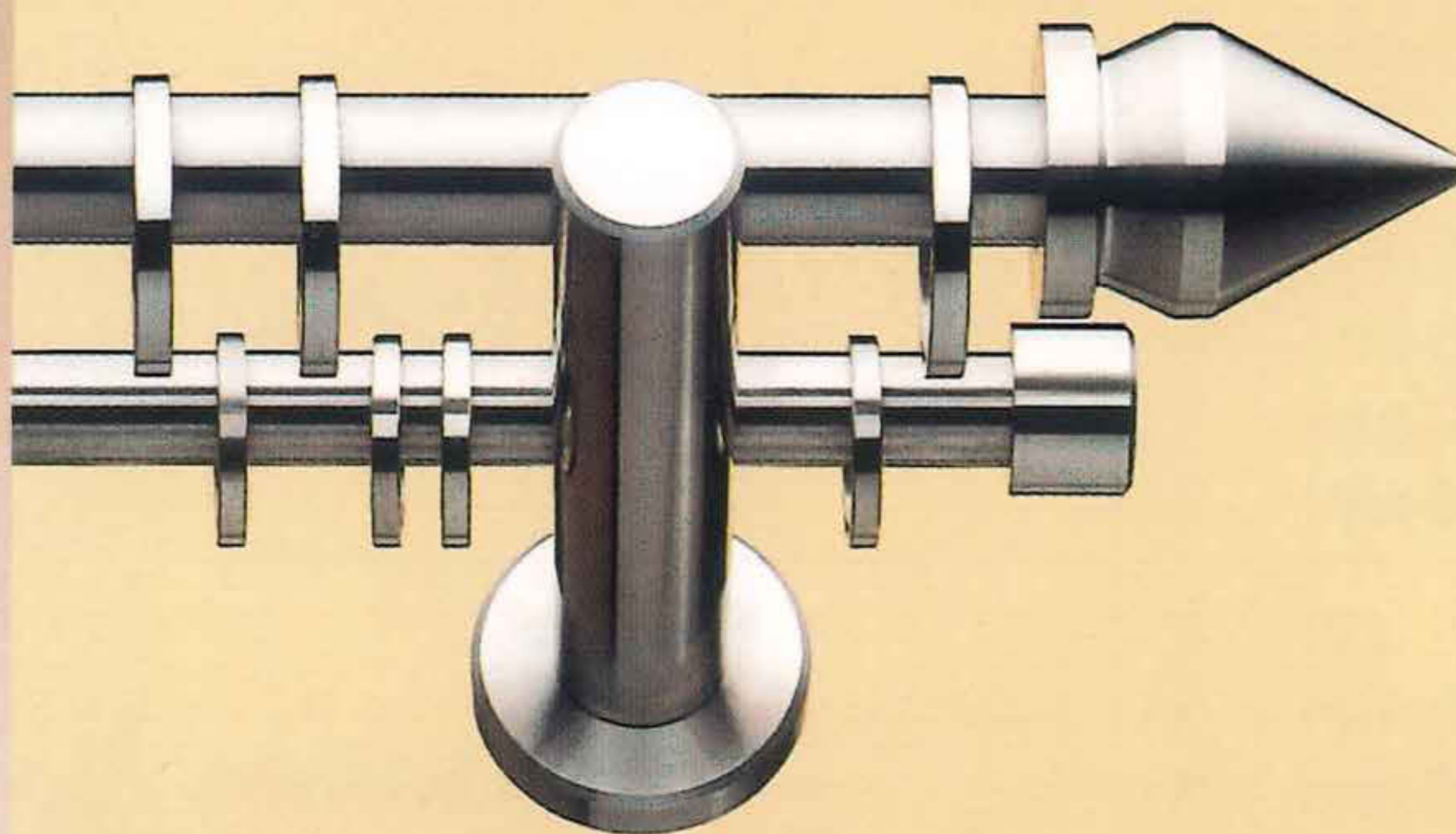

Mod. Moskau - Berlin Ø 16 mm, Art. 16.13-01  
Abb. Mod. Moskau - Berlin Ø 20 mm, Art. 20.13-01  
Mod. Moskau - Berlin Ø 25 mm, Art. 25.13-01

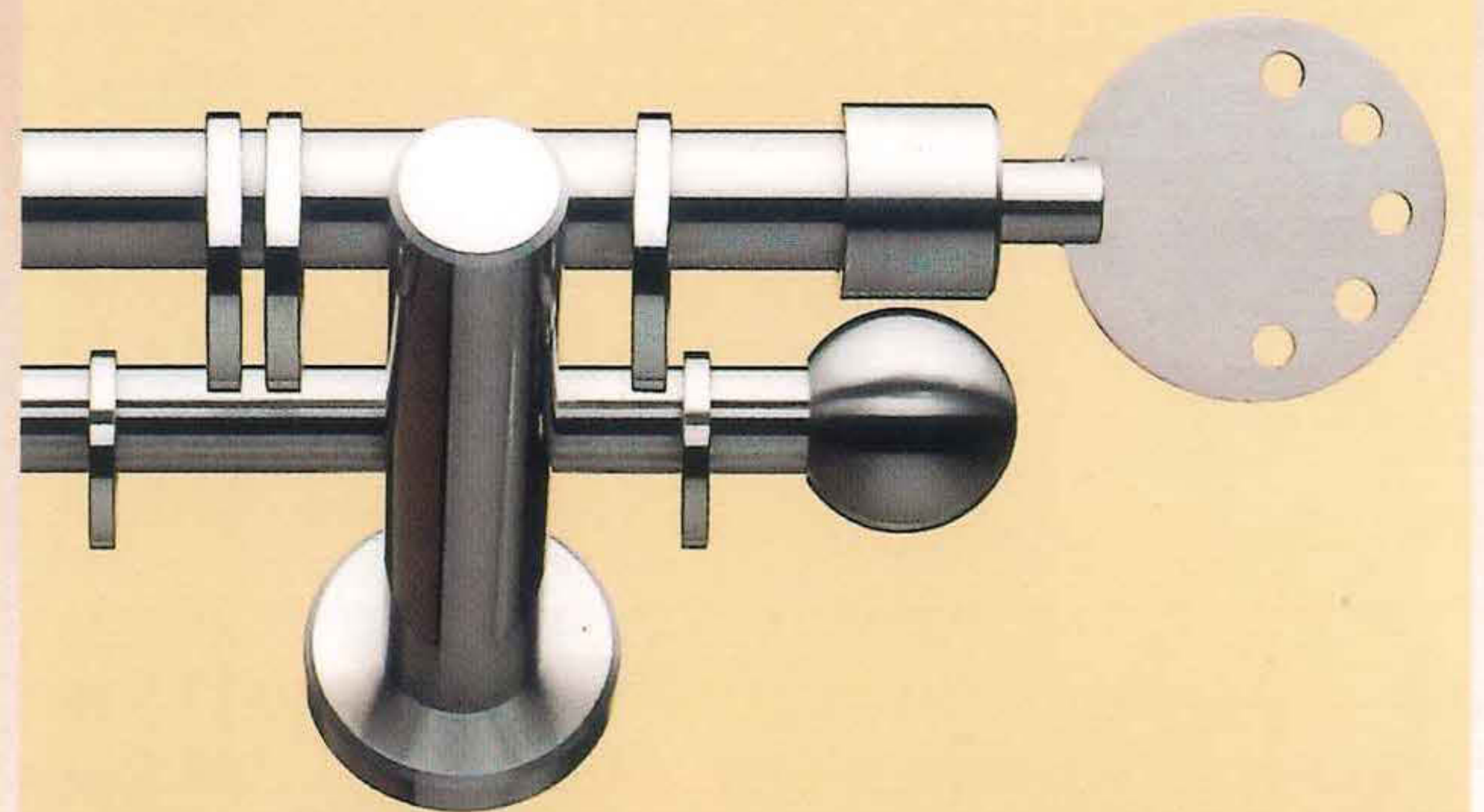

Mod. Helsinki - Lissabon Ø 16 mm, Art. 16.32-26  
Abb. Mod. Helsinki - Lissabon Ø 20 mm, Art. 20.32-26  
Mod. Helsinki - Lissabon Ø 25 mm, Art. 25.32-26

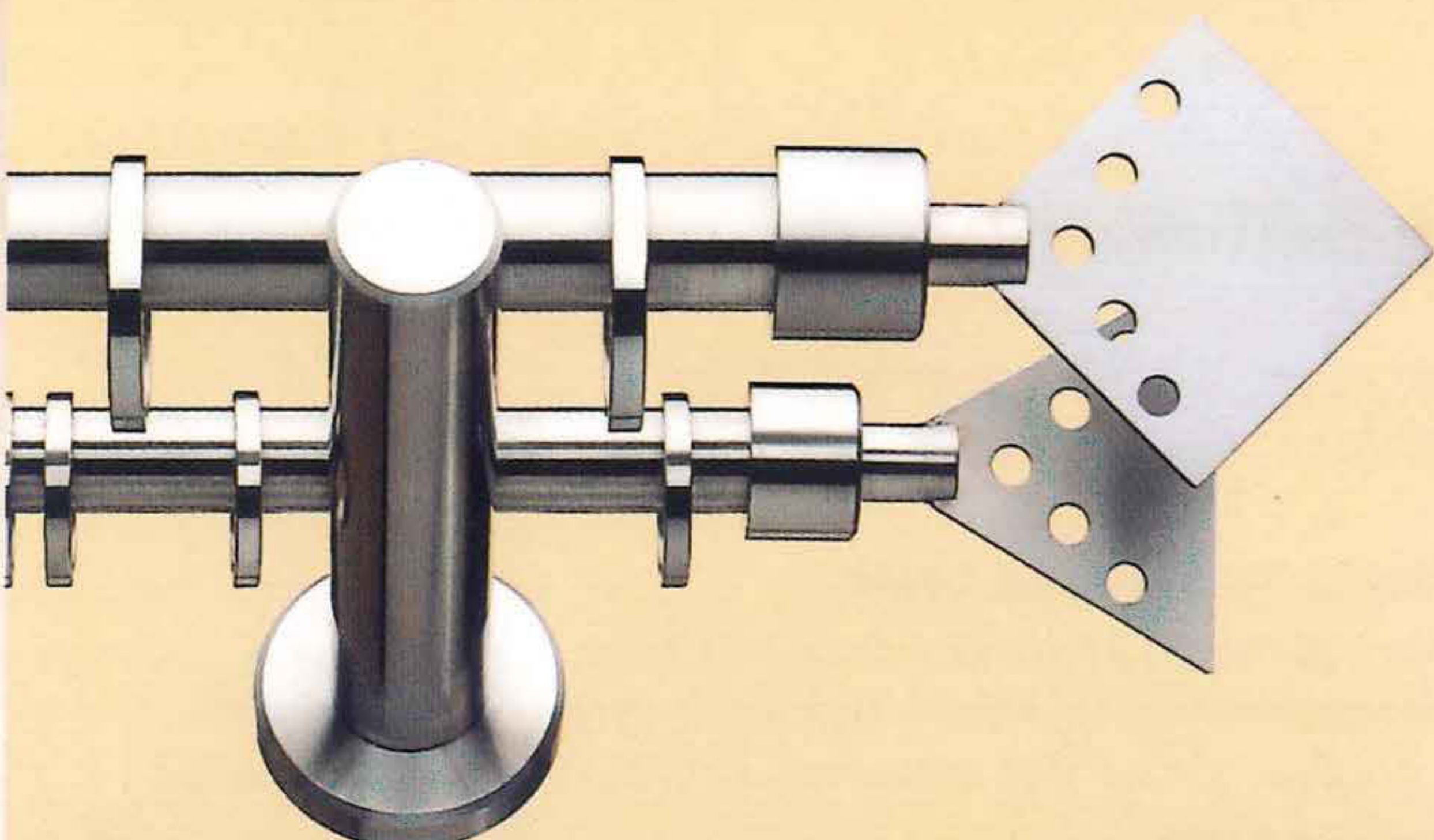

Mod. Prag - Budapest Ø 16 mm, Art. 16.31-33  
Abb. Mod. Prag - Budapest Ø 20 mm, Art. 20.31-33  
Mod. Prag - Budapest Ø 25 mm, Art. 25.31-33

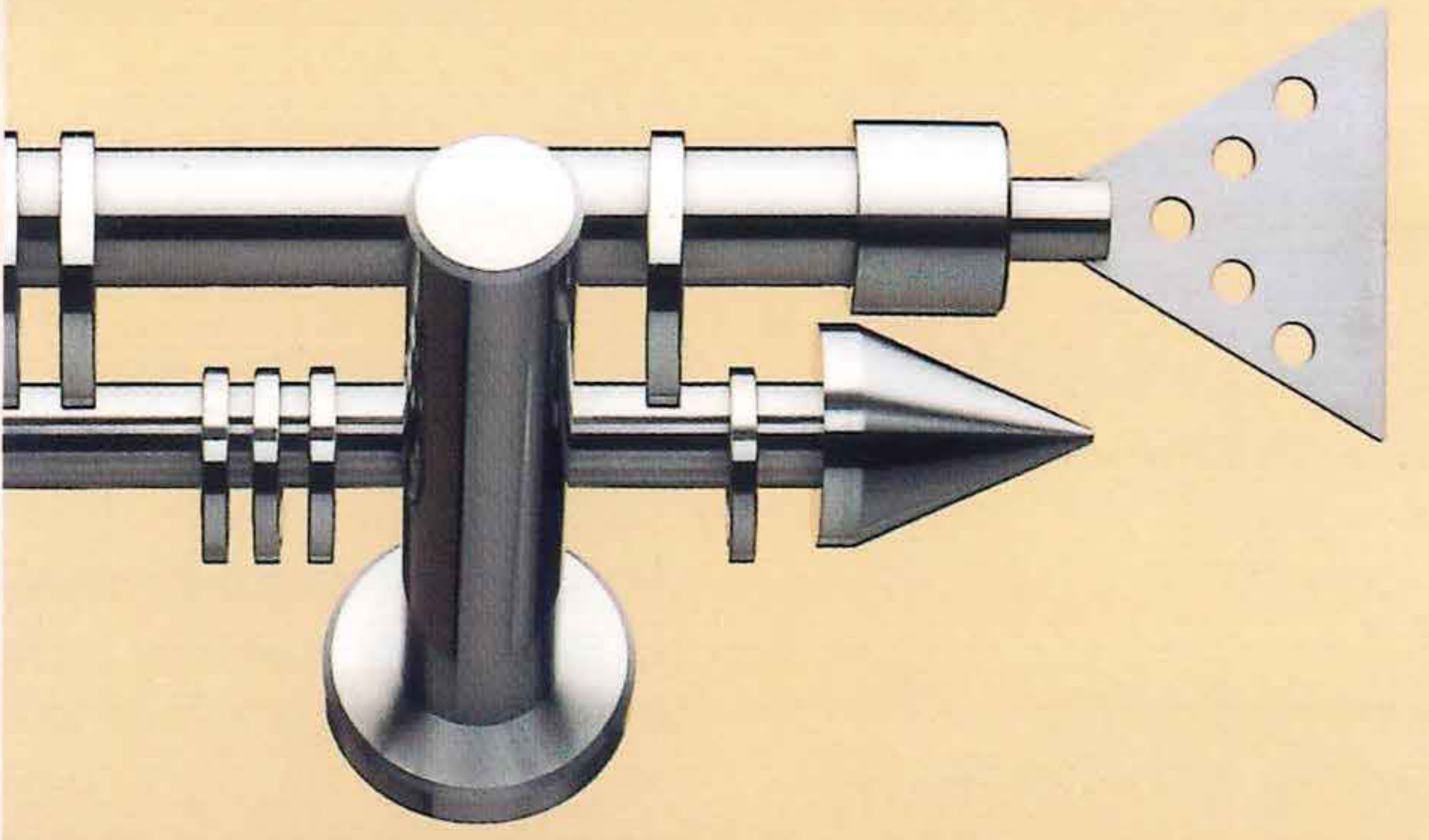

Mod. Budapest - Paris Ø 16 mm, Art. 16.33-11  
Abb. Mod. Budapest - Paris Ø 20 mm, Art. 20.33-11  
Mod. Budapest - Paris Ø 25 mm, Art. 25.33-11

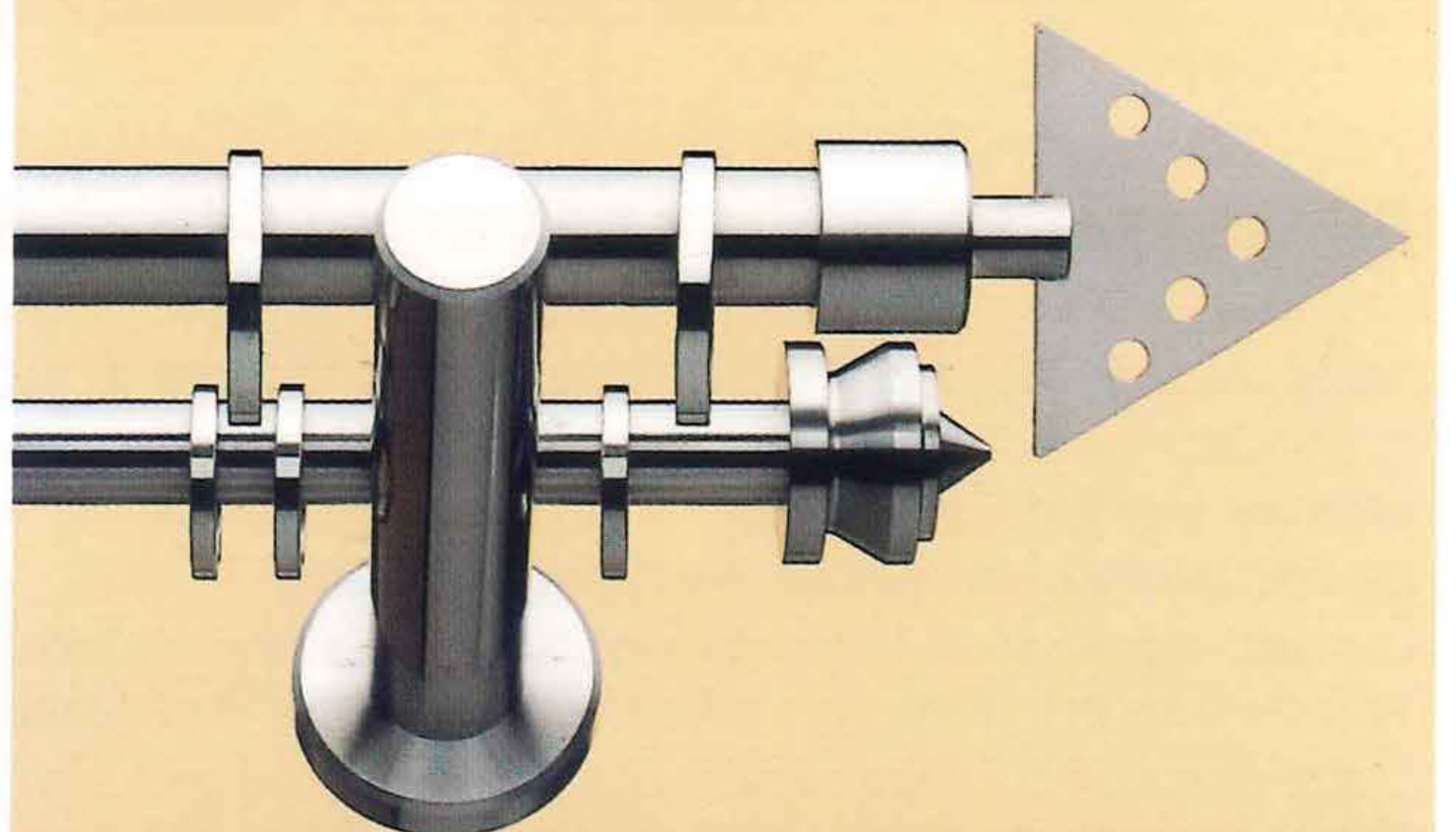

Mod. Stockholm - Nepal Ø 16 mm, Art. 16.34-12  
Abb. Mod. Stockholm - Nepal Ø 20 mm, Art. 20.34-12  
Mod. Stockholm - Nepal Ø 25 mm, Art. 25.34-12

Mehr als 100 verschiedene Kombinationen sind möglich.  
Oltre 100 diverse combinazioni possibili.

Die hintere Stange hat immer einen Ø von 16 mm  
L'asta tubolare posteriore ha sempre un Ø di 16 mm

# Sonnenschutz-Vorhangelemente Elementi tenda e parasole

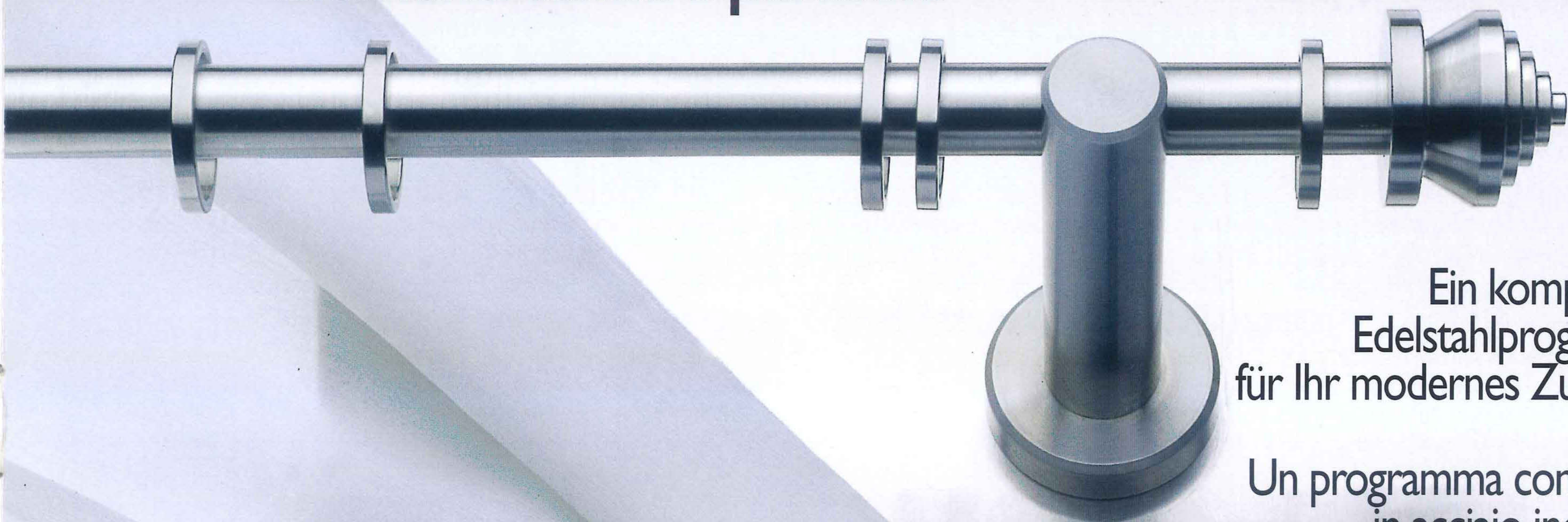

Ein komplettes  
Edelstahlprogramm  
für Ihr modernes Zuhause

Un programma completo  
in acciaio inox per  
la vostra casa moderna

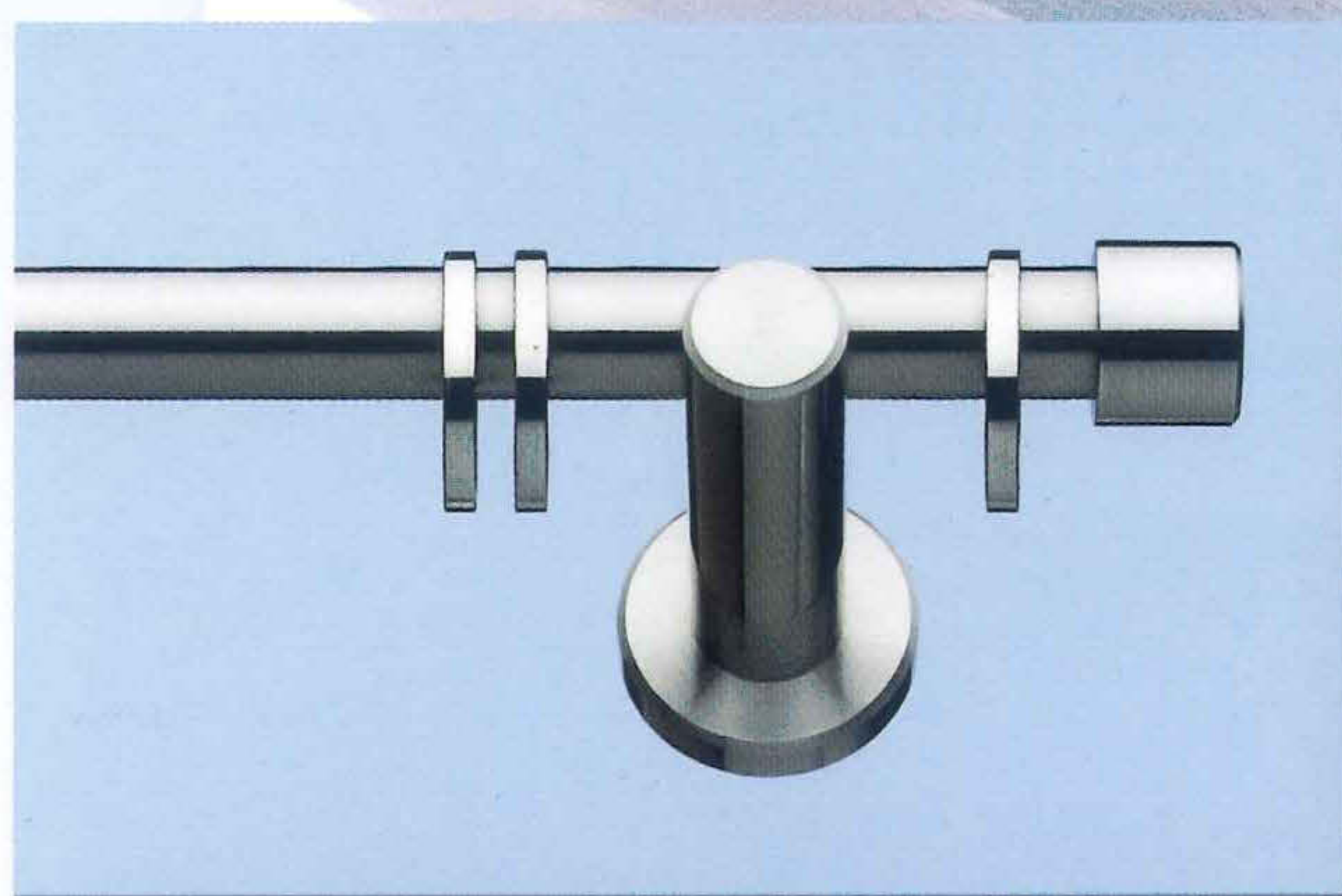

Mod. Berlin Ø 16 mm, Art. 16.01  
Abb. Mod. Berlin Ø 20 mm, Art. 20.01  
Mod. Berlin Ø 25 mm, Art. 25.01

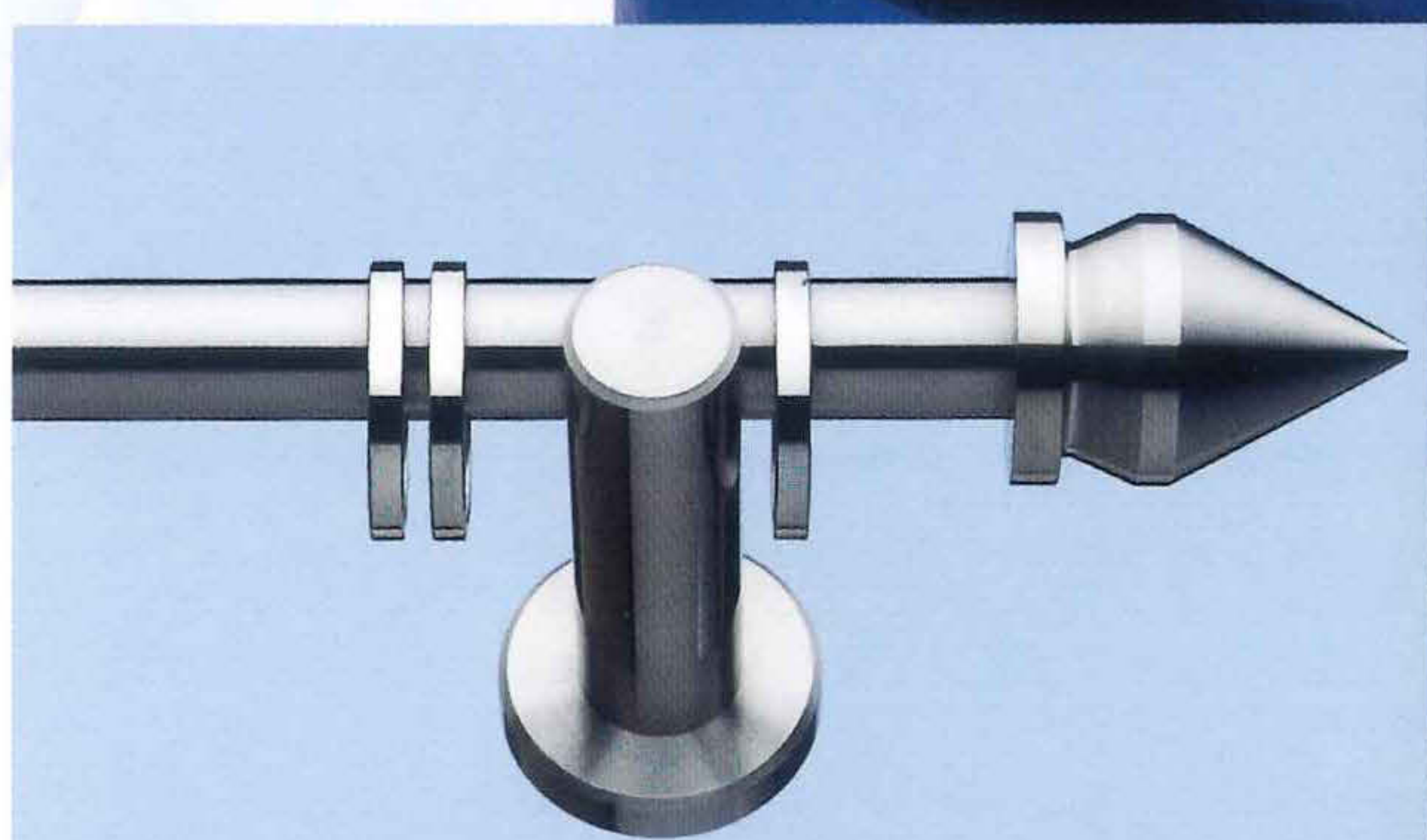

Mod. Moskau Ø 16 mm, Art. 16.13  
Abb. Mod. Moskau Ø 20 mm, Art. 20.13  
Mod. Moskau Ø 25 mm, Art. 25.13

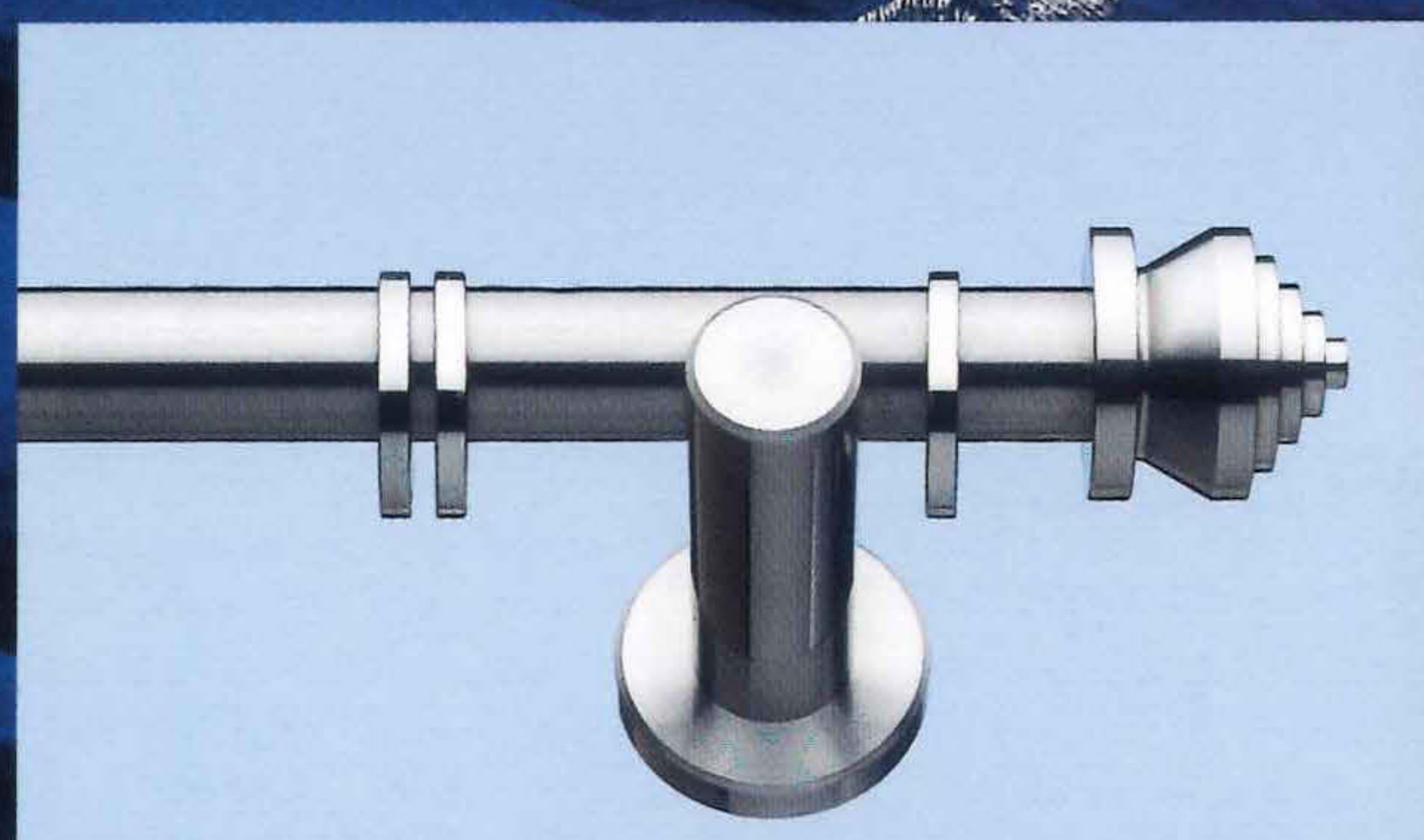

Mod. Kairo Ø 16 mm, Art. 16.06  
Abb. Mod. Kairo Ø 20 mm, Art. 20.06  
Mod. Kairo Ø 25 mm, Art. 25.06

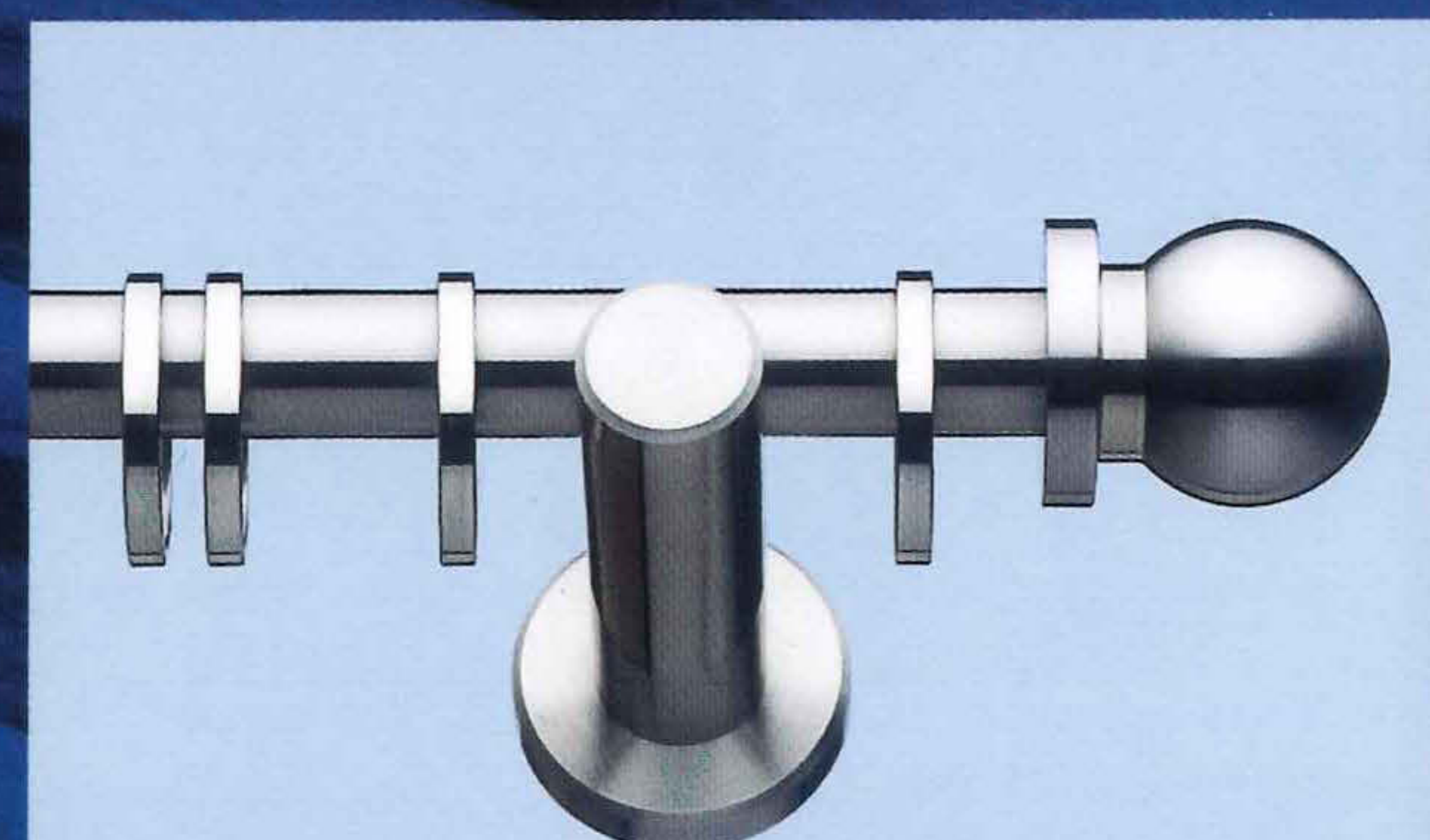

Mod. Madrid Ø 16 mm, Art. 16.22  
Abb. Mod. Madrid Ø 20 mm, Art. 20.22  
Mod. Madrid Ø 25 mm, Art. 25.22

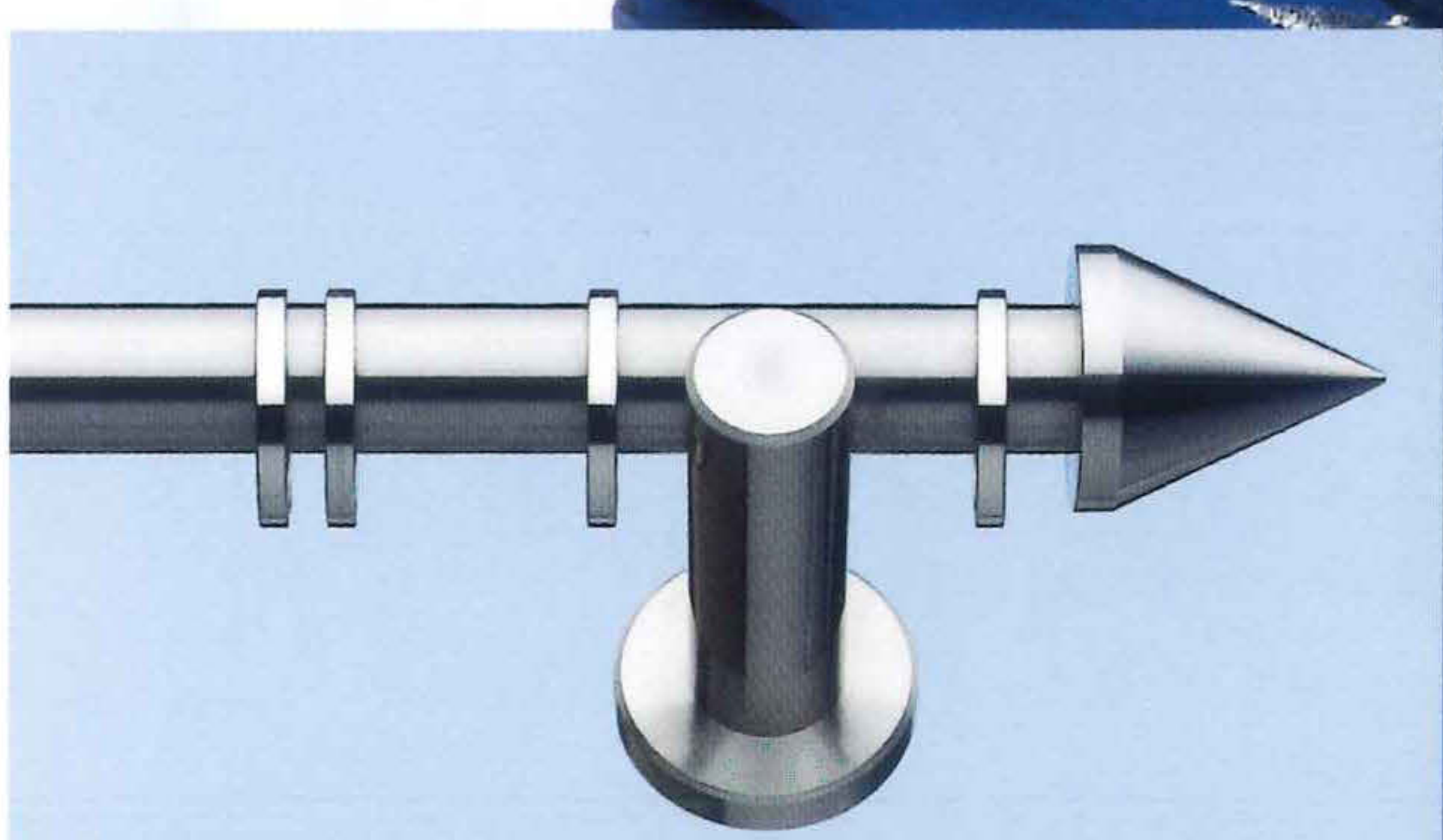

Mod. Paris Ø 16 mm, Art. 16.11  
Mod. Paris Ø 20 mm, Art. 20.11  
Abb. Mod. Paris Ø 25 mm, Art. 25.11



Abb. Mod. Istanbul Ø 16 mm, Art. 16.23  
Mod. Istanbul Ø 20 mm, Art. 20.23  
Mod. Istanbul Ø 25 mm, Art. 25.23



Mod. Nepal Ø 16 mm, 16.12  
Abb. Mod. Nepal Ø 20 mm, 20.12  
Mod. Nepal Ø 25 mm, 25.12

# Sonnenschutz-Vorhangelemente Elementi tenda e parasole

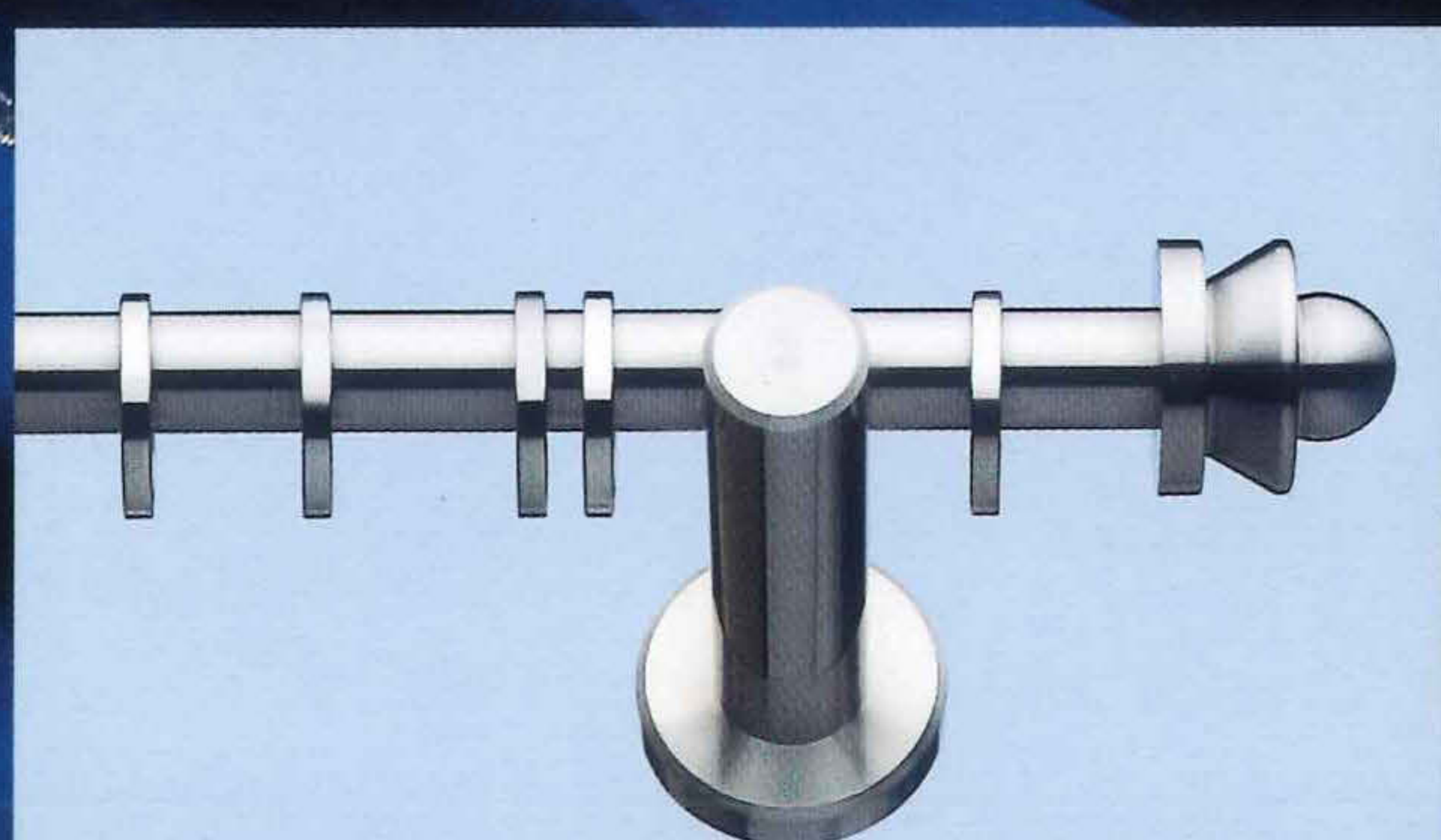
**decordesign**

Lassen Sie  
Ihr Heim  
noch schöner  
werden

Rendete ancora  
più bella la  
vostra abitazione

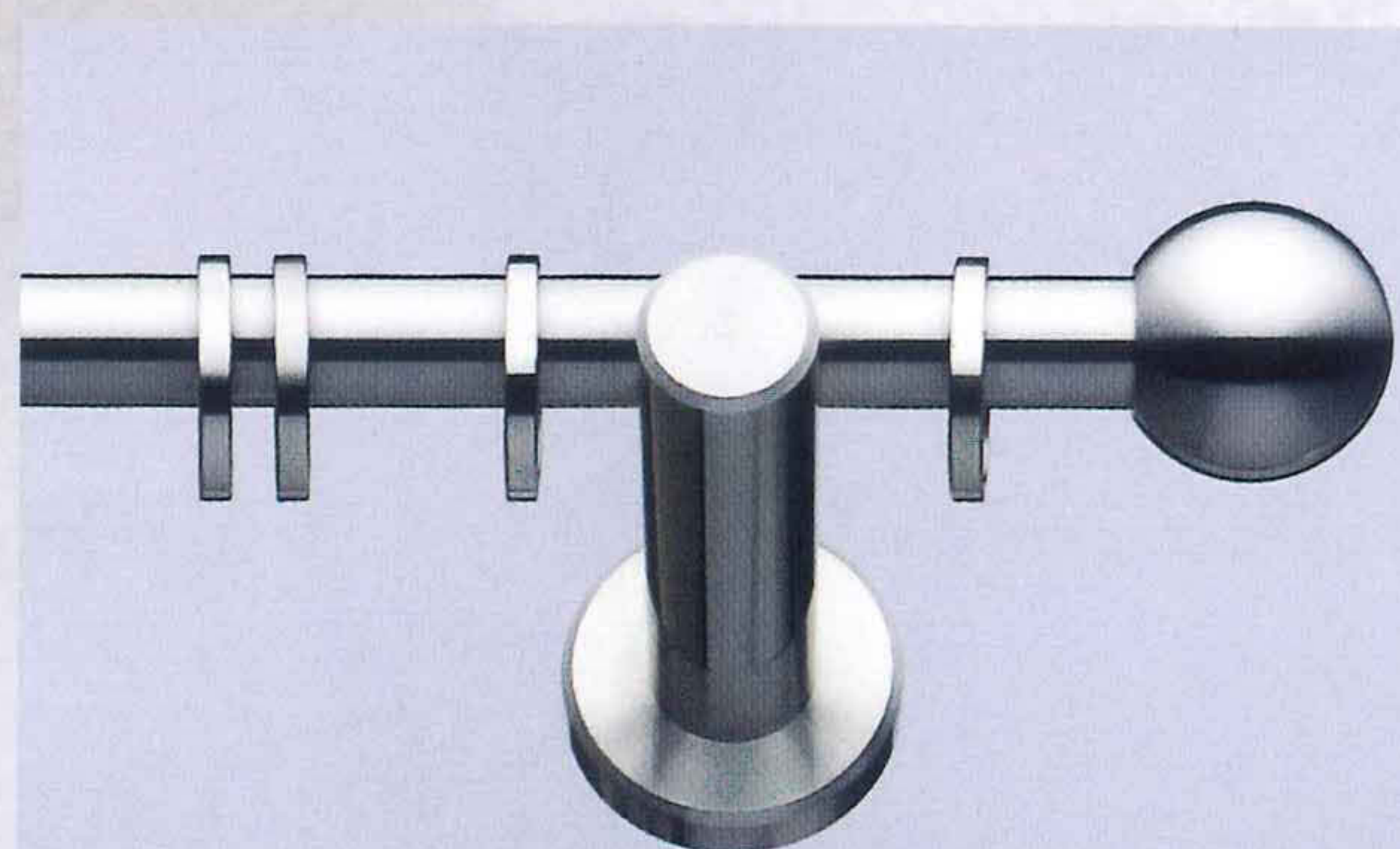

Mod. Lissabon Ø 16 mm, Art. 16.26  
Abb. Mod. Lissabon Ø 20 mm, Art. 20.26  
Mod. Lissabon Ø 25 mm, Art. 25.26

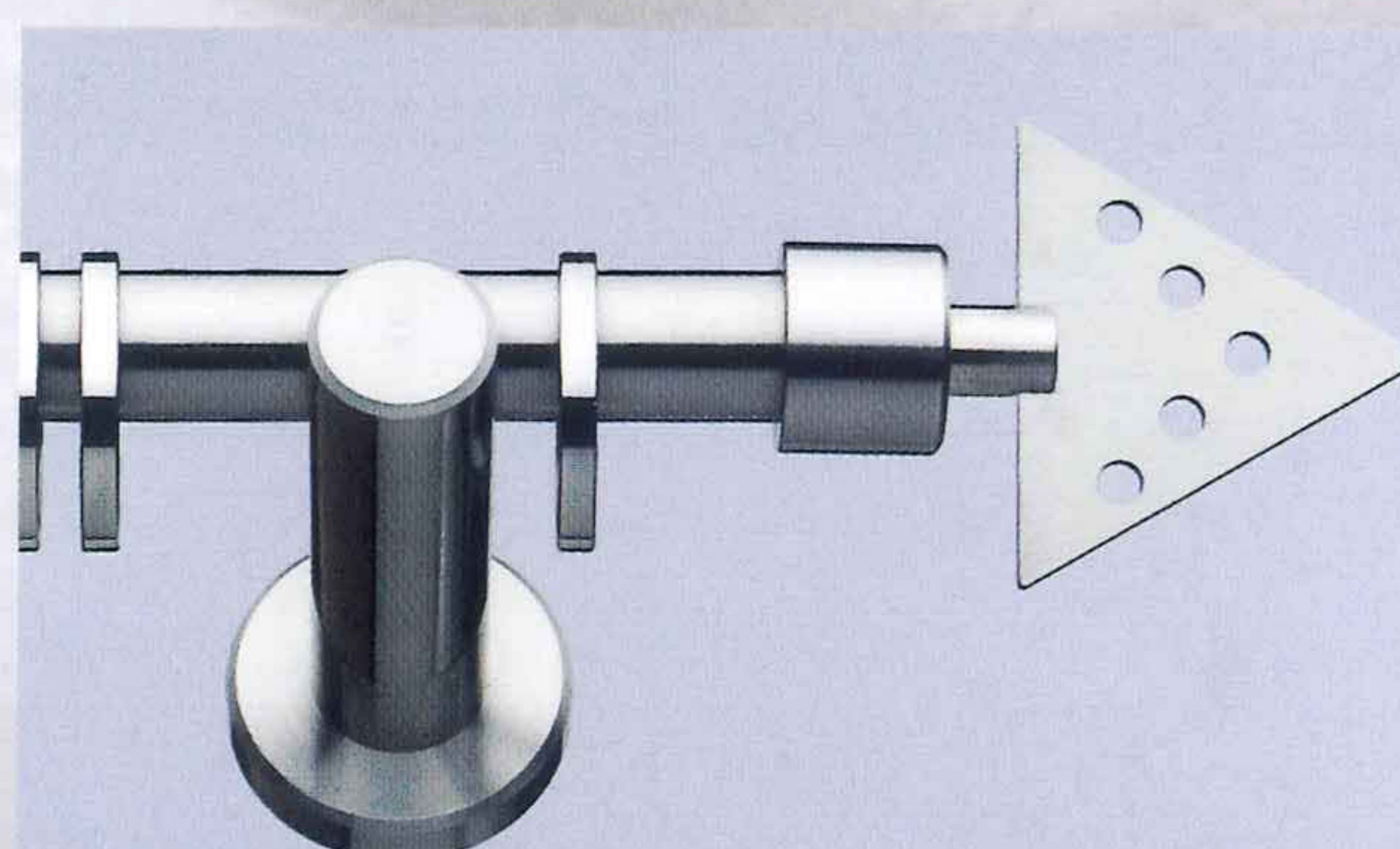

Mod. Stockholm Ø 16 mm, Art. 16.34  
Abb. Mod. Stockholm Ø 20 mm, Art. 20.34  
Mod. Stockholm Ø 25 mm, Art. 25.34

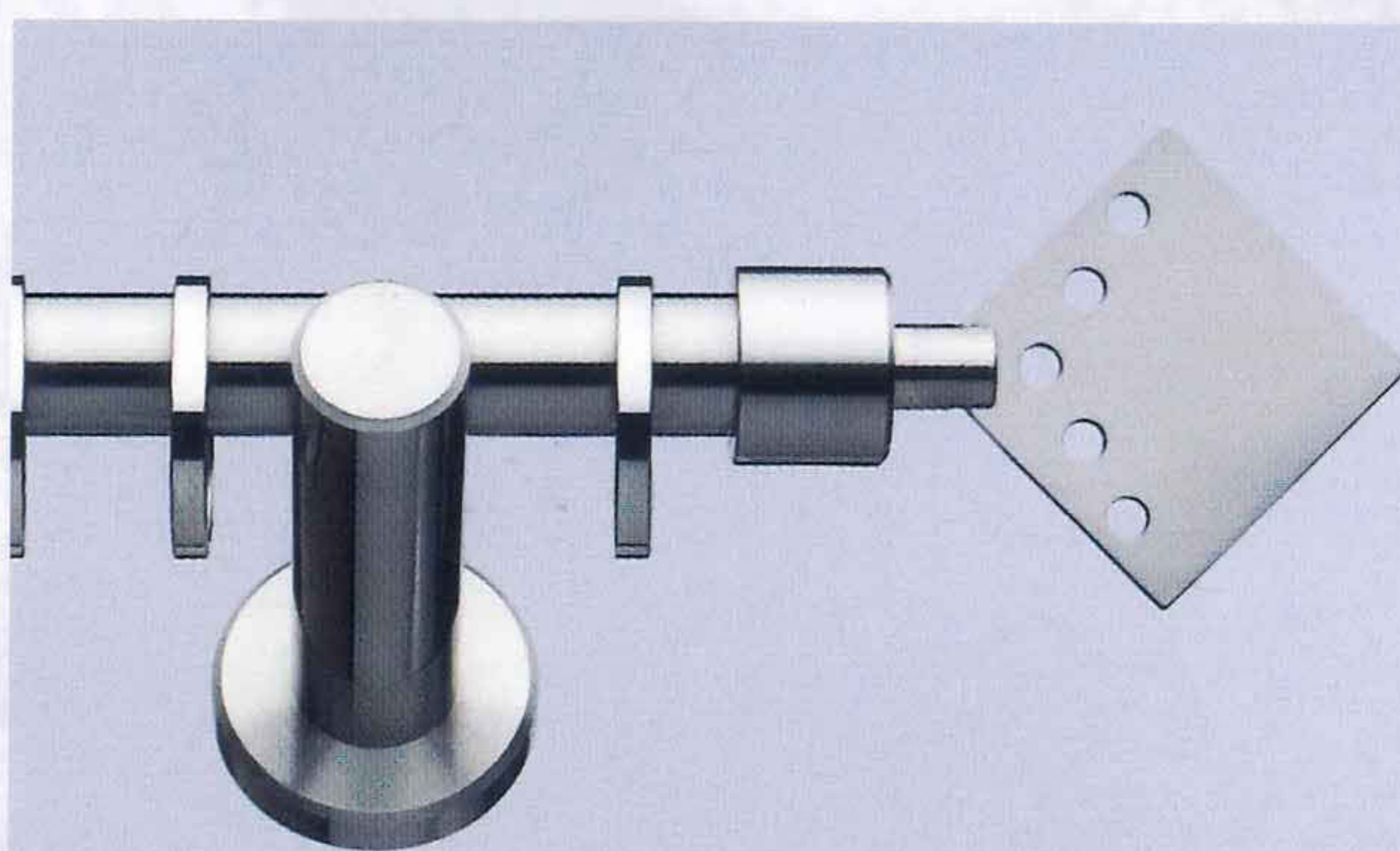

Mod. Prag Ø 16 mm, Art. 16.31  
Abb. Mod. Prag Ø 20 mm, Art. 20.31  
Mod. Prag Ø 25 mm, Art. 25.31

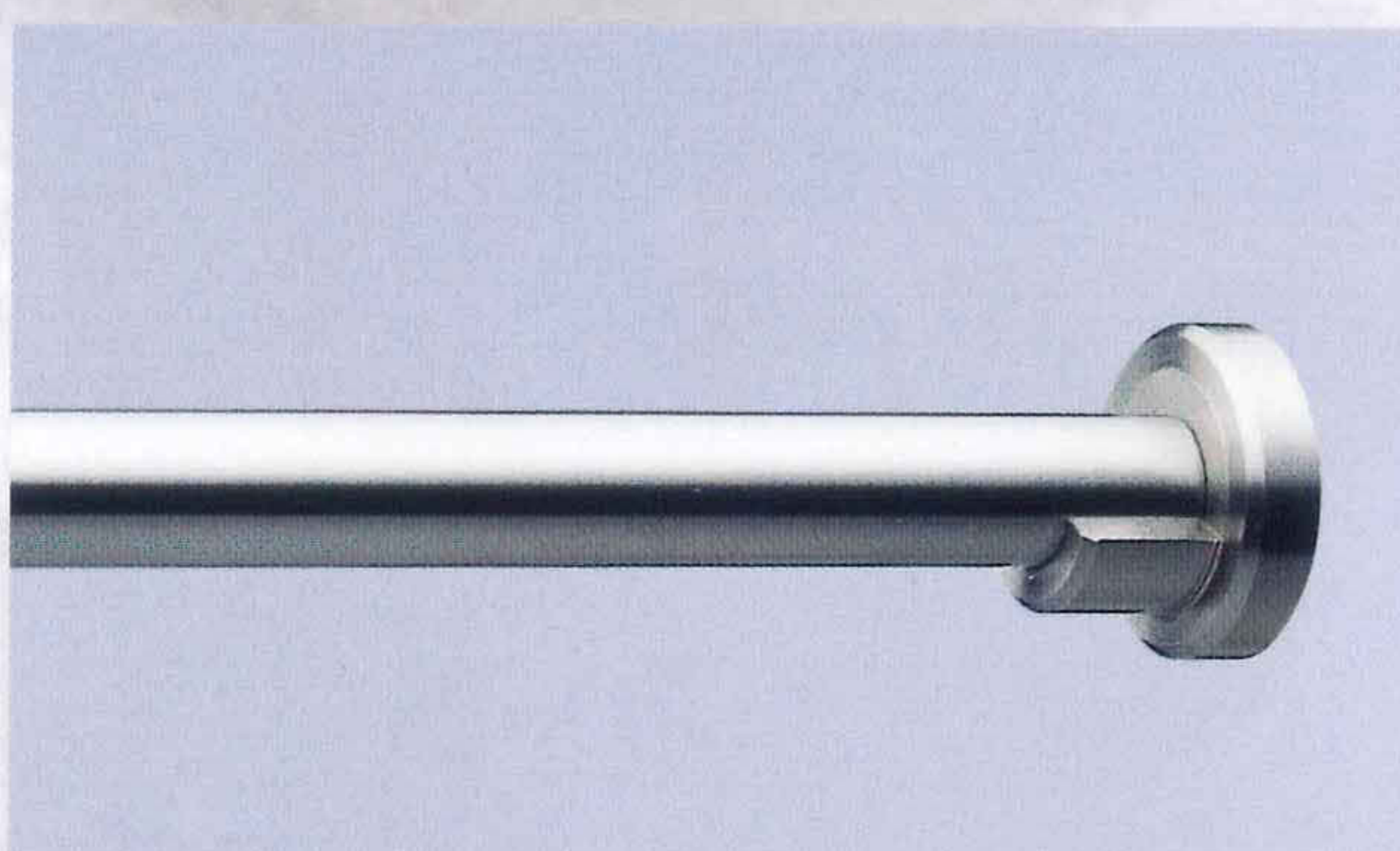

Mod. Kiew Ø 16 mm, Art. 16.41  
Abb. Mod. Kiew Ø 20 mm, Art. 20.41  
Mod. Kiew Ø 25 mm, Art. 25.41

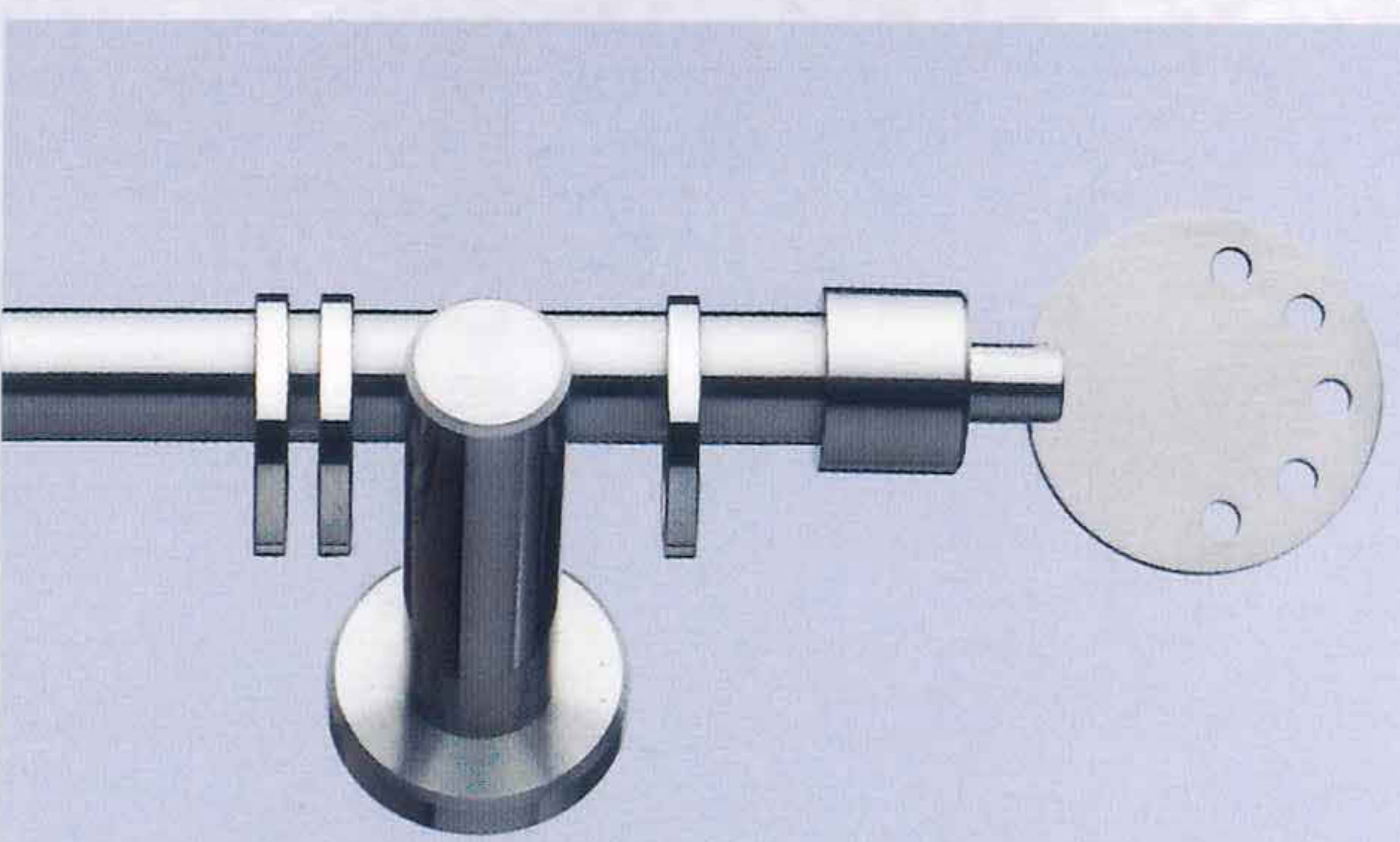

Mod. Helsinki Ø 16 mm, Art. 16.32  
Abb. Mod. Helsinki Ø 20 mm, Art. 20.32  
Mod. Helsinki Ø 25 mm, Art. 25.32

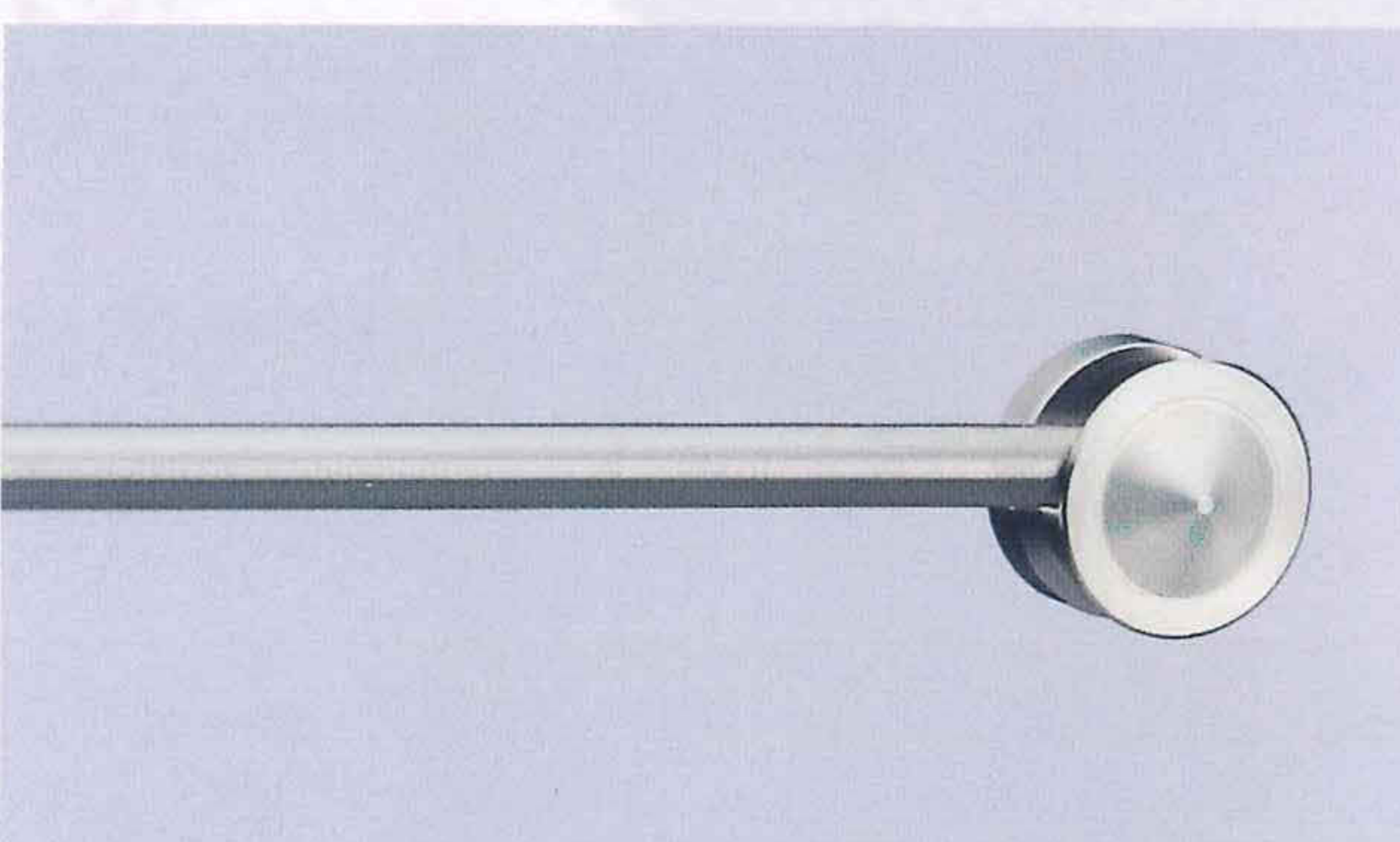

Gardinenelement - Elementi tendine  
Mod. Bern Ø 10 mm, Art. 10.51

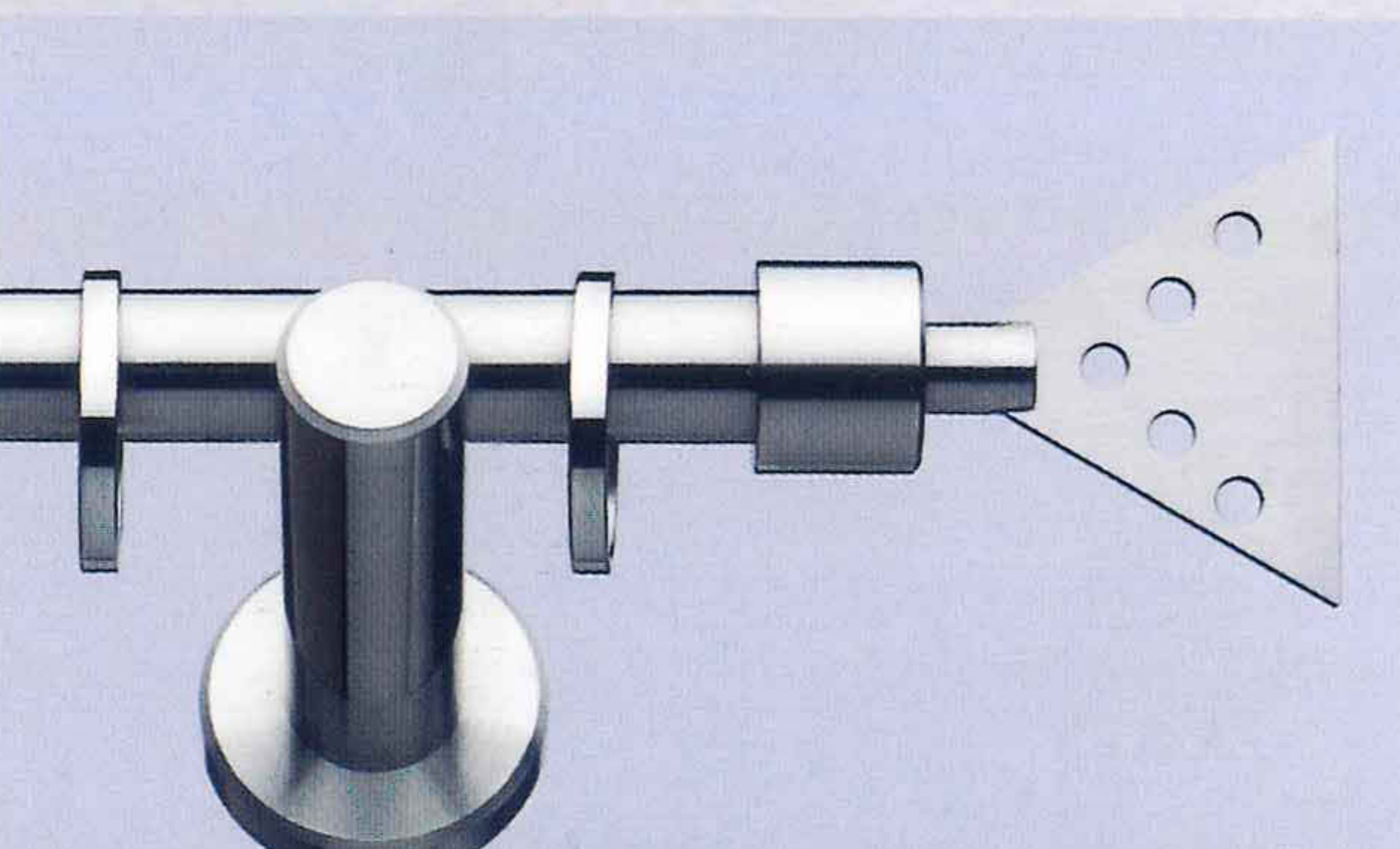

Mod. Budapest Ø 16 mm, Art. 16.33  
Abb. Mod. Budapest Ø 20 mm, Art. 20.33  
Mod. Budapest Ø 25 mm, Art. 25.33

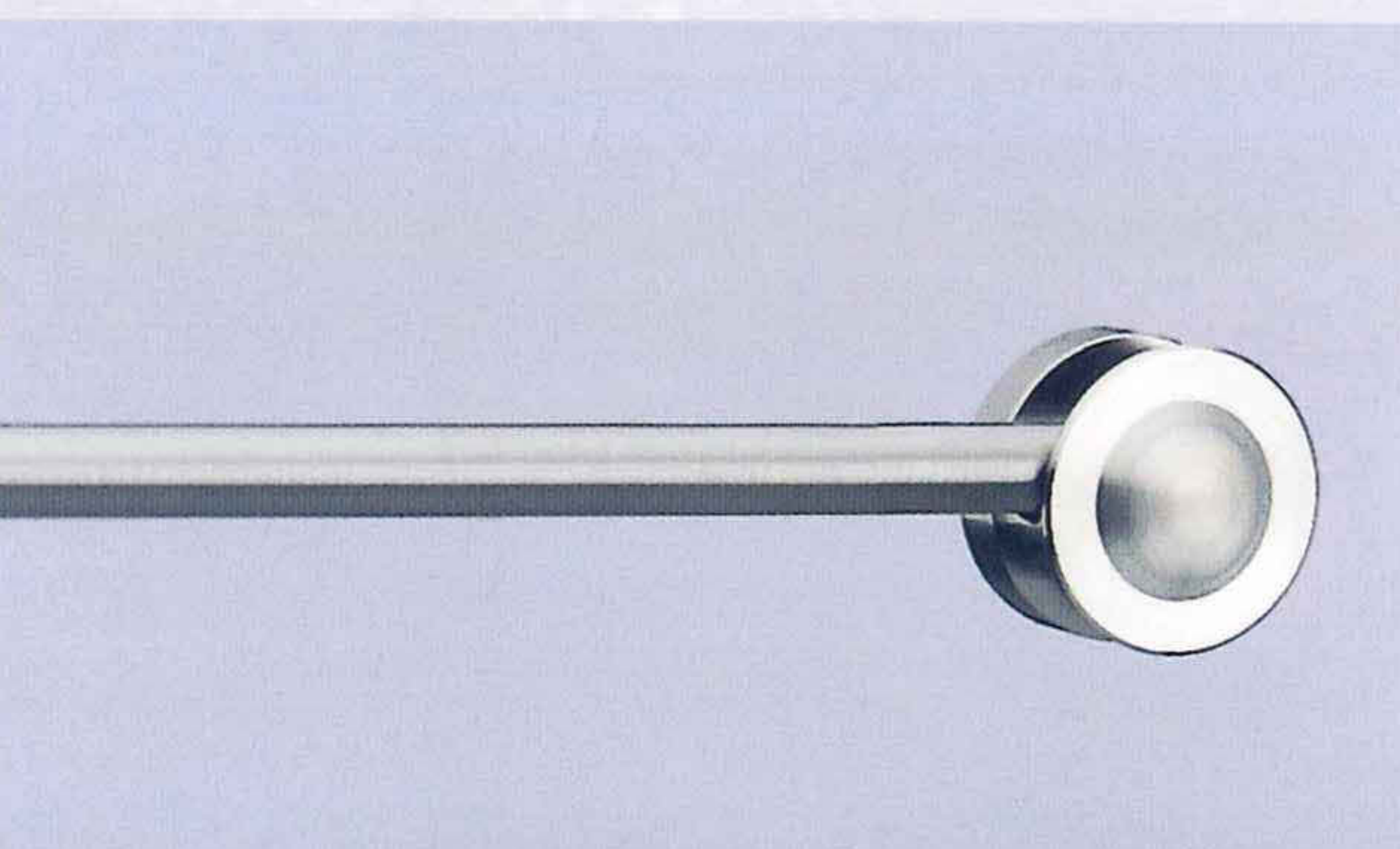

Gardinenelement - Elementi tendine  
Mod. Zürich Ø 10 mm, Art. 10.56

# Sonnenschutz - Vorhangelemente Elementi tenda e parasole

Vorhangelemente aus Edelstahl eine moderne und dennoch zeitlose Dekorationsmöglichkeit für Vorhänge und Gardinen.

Ein angenehmer Blickfang in jedem Wohnraum und Büro ob modern oder klassisch eingerichtet.

Unsere Doppelvorhangelemente erlauben eine Vielzahl an Kombinationsmöglichkeiten.

Wählen Sie aus drei Rundstangen und 12 verschiedenen Endstücken.

- Bei den Doppelvorhangelementen hat die hintere Rundstange immer einen Ø von 16 mm.
- Die Rundstangenelemente sind in den Längen 300 mm bis 4.000 mm erhältlich.
- Auf Anfrage sind Rundstangenelemente mit Sonderlängen lieferbar.
- Bei längeren Vorhangelementen bitte zusätzlichen Halter für die Mitte mitbestellen.
- Ringe müssen getrennt bestellt werden.

Ringe zur Auswahl:

- Ø 30 mm Art. Nr. 16.34.130
- Ø 40 mm Art. Nr. 20.39.140
- Ø 50 mm Art. Nr. 25.44.150

Elementi tenda in acciaio inox, una possibilità di decorazione moderna e ciò nonostante senza tempo per tende e tendine. Un richiamo piacevole in ogni ambiente abitativo ed in ufficio, sia con arredo classico che moderno.

I nostri elementi a tenda doppia consentono un gran numero di combinazioni.

Potete scegliere fra tre aste tubolari e 12 diversi elementi terminali.

- Per gli elementi a tenda doppia, l'asta tubolare posteriore ha sempre un Ø di 16 mm.
- Gli elementi tubolari sono disponibili nelle lunghezze da 300 mm a 4.000 mm.
- Su richiesta gli elementi tubolari possono essere forniti in lunghezze particolari.
- In caso di elementi particolarmente lunghi si prega di ordinare anche un sostegno aggiuntivo al centro.
- Gli anelli devono essere ordinati separatamente.

A scelta

- Ø 30 mm Art. Nr. 16.34.130
- Ø 40 mm Art. Nr. 20.39.140
- Ø 50 mm Art. Nr. 25.44.150

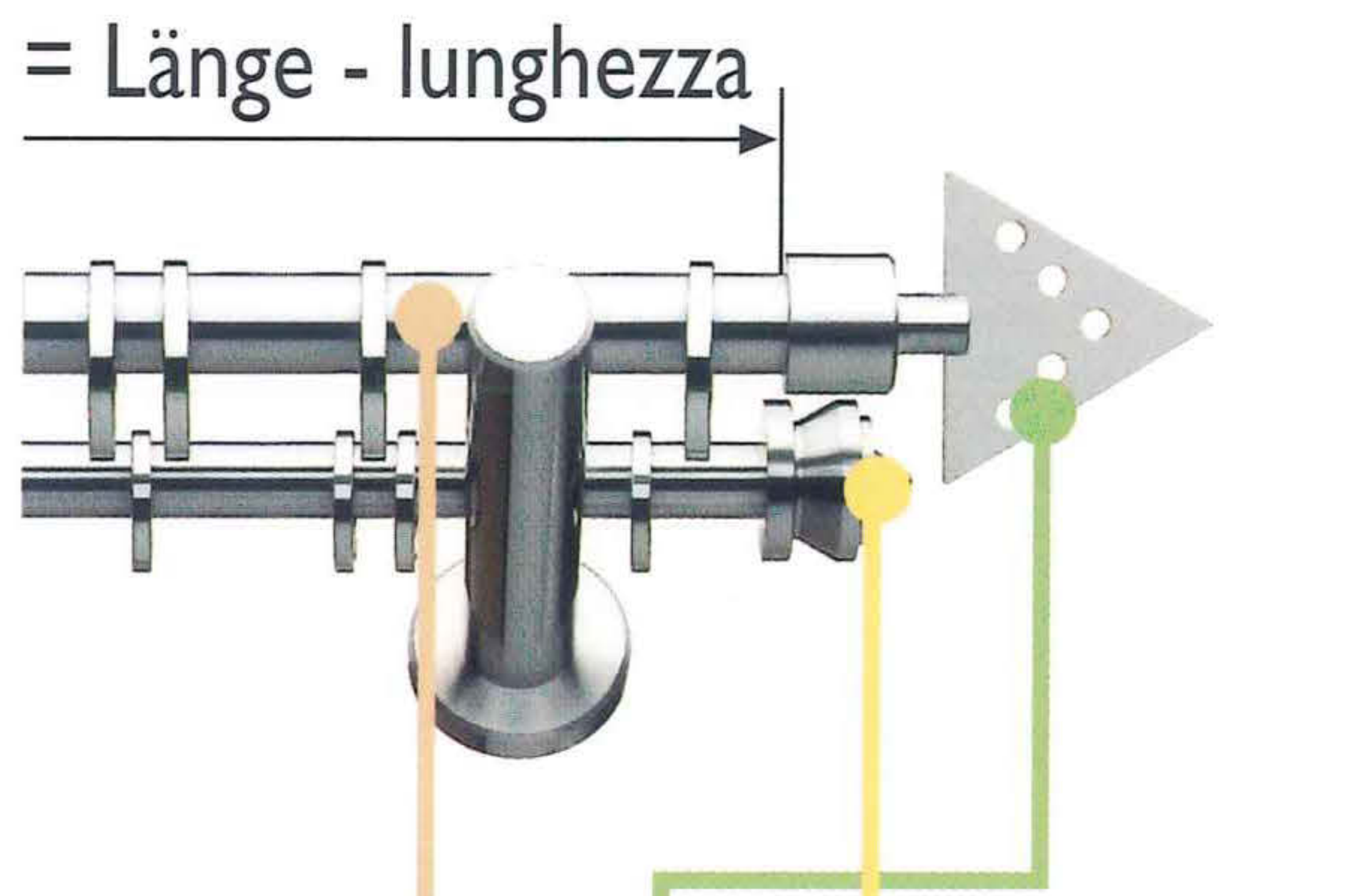

<b>20</b>	<b>34</b>	<b>12</b>	Länge mm lunghezza mm
Ø Rundstangen: 16, 20, 25 mm Ø elementi tubolari	Modell Endstück vorne modello elemento terminale anteriore	Modell Endstück hinten modello elemento terminale posteriore	Länge in mm angeben lunghezza in mm

	Berlin	<b>01</b>
	Kairo	<b>06</b>
	Paris	<b>11</b>
	Nepal	<b>12</b>
	Moskau	<b>13</b>
	Madrid	<b>22</b>
	Istanbul	<b>23</b>
	Lissabon	<b>26</b>
	Prag	<b>31</b>
	Helsinki	<b>32</b>
	Budapest	<b>33</b>
	Stockholm	<b>34</b>

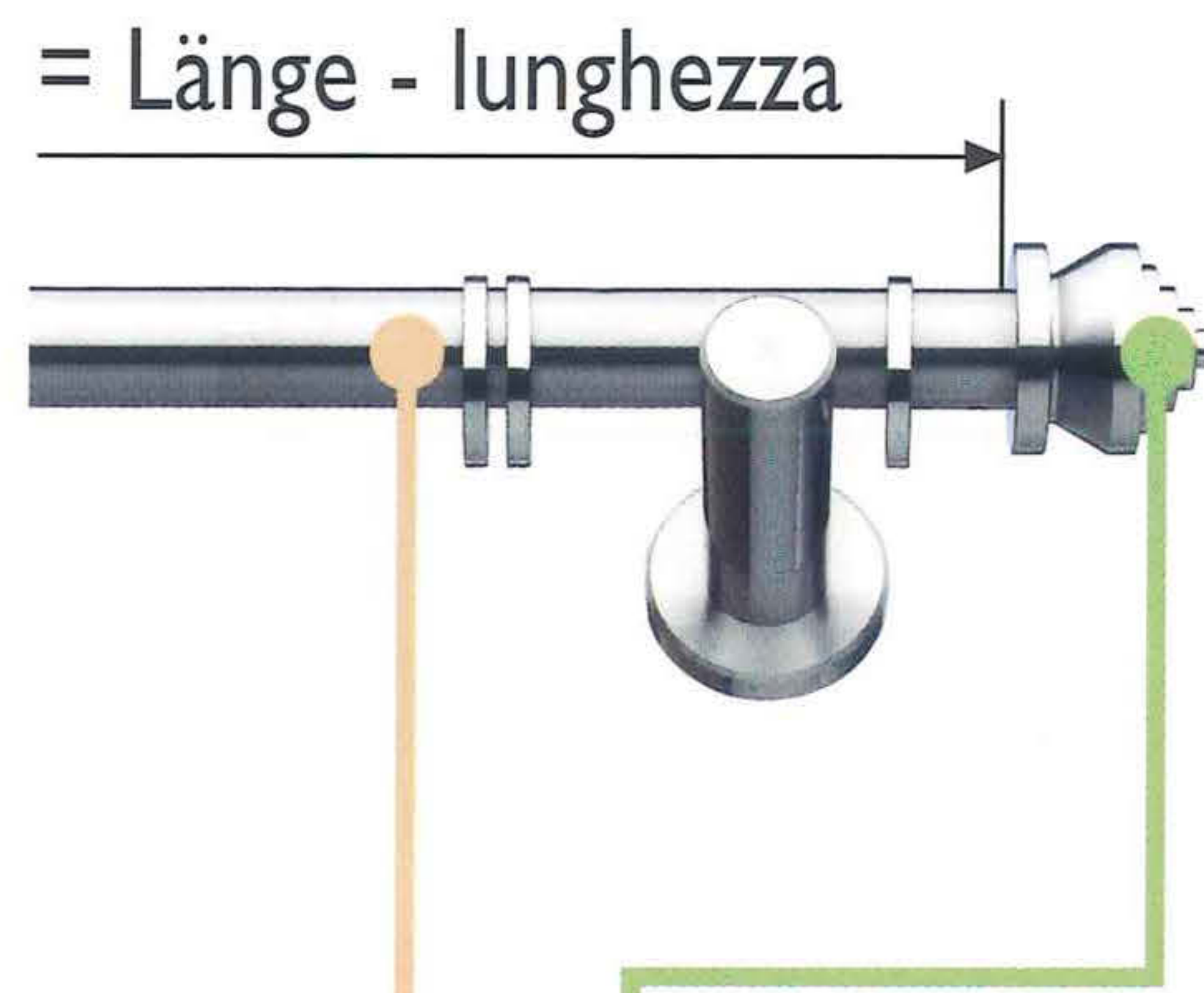

<b>25</b>	<b>06</b>	Länge mm lunghezza mm
Ø Rundstangen: 16, 20, 25 mm Ø elementi tubolari	Modell Endstück modello elemento terminale	Länge in mm angeben lunghezza in mm

	Berlin	<b>01</b>
	Kairo	<b>06</b>
	Paris	<b>11</b>
	Nepal	<b>12</b>
	Moskau	<b>13</b>
	Madrid	<b>22</b>
	Istanbul	<b>23</b>
	Lissabon	<b>26</b>
	Prag	<b>31</b>
	Helsinki	<b>32</b>
	Budapest	<b>33</b>
	Stockholm	<b>34</b>